

7. Airbag Control Module

A: REMOVAL

CAUTION:

- Do not disassemble the airbag control module.
- If the airbag control module is deformed or if water damage is suspected, replace the airbag control module with a new genuine part.
- Do not drop the airbag control module.
- After removal, keep the airbag control module on a dry, clean surface away from moisture, heat, and dust.

- 1) Turn the ignition switch to OFF.
- 2) Disconnect the ground cable from battery, and wait for at least 20 seconds before starting work.
- 3) Remove the console cover. <Ref. to EI-36, REMOVAL, Console Box.>
- 4) Remove the center console panel. <Ref. to EI-37, REMOVAL, Instrument Panel Assembly.>
- 5) Disconnect the connector from airbag control module.
- 6) Remove the four bolts.

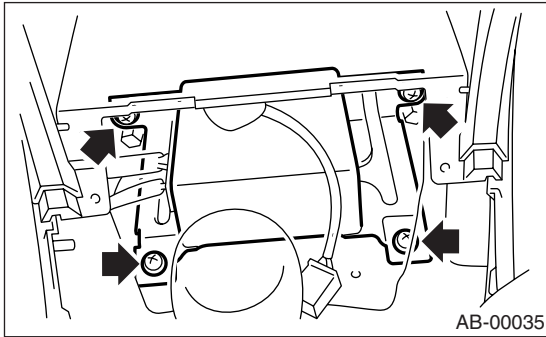

B: INSTALLATION

CAUTION:

Use new hexagon head bolts (for airbag control module only) during reassembly.

Install in the reverse order of removal.

Tightening torque:

Refer to “COMPONENT” in “General Description” <Ref. to AB-2, SRS AIRBAG, COMPONENT, General Description.>

C: INSPECTION

Check for the following, and replace damaged parts with new parts.

- Control module, connector, and mounting bracket are damaged.
- Airbag is deployed.
- Side airbag is deployed.